

Measuring orifice VMO

Product brochure · GB

3 Edition 08.11

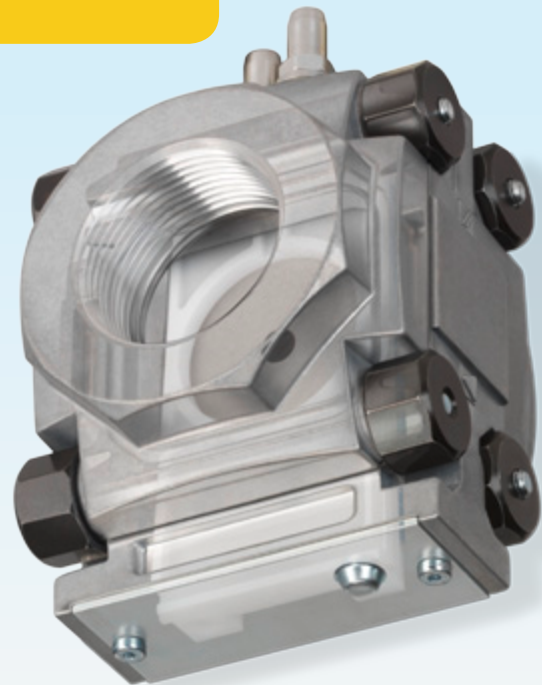

- For use as a measuring or restricting orifice
- Can be combined with valVario valves and regulators
- Air and gas flow rate diagrams to facilitate configuration
- Easy installation thanks to flanges with internal thread
- Replaceable aluminium washers for optimal adjustment to local operating conditions

valVario®

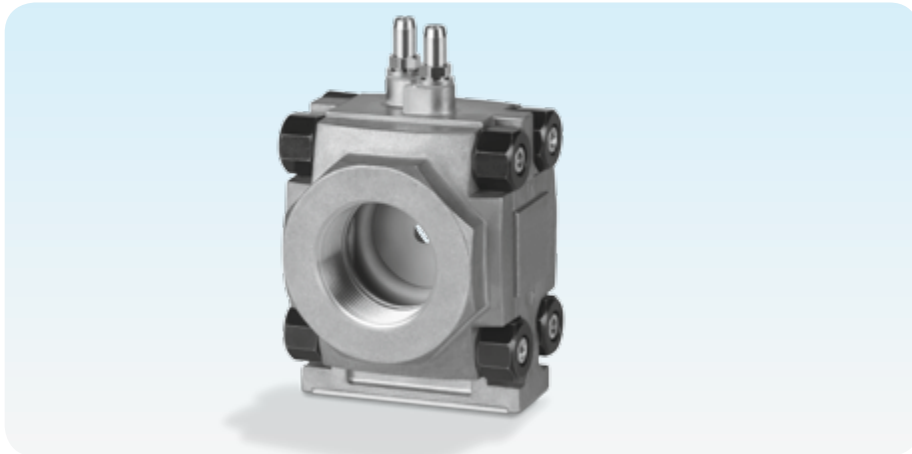

Application

The valVario measuring orifice VMO is installed in gas control and safety systems, as well as in air systems used in industrial and commercial gas heat generation. It can serve as a restricting orifice when used in conjunction with valVario gas solenoid valves and gas control valves.

The test points are located in the measuring orifice housing. The measuring orifice VMO is a good-value alternative in areas where no standardized measuring orifice is required. The replaceable washers with different hole sizes allow the orifice to be adjusted perfectly to the local operating conditions.

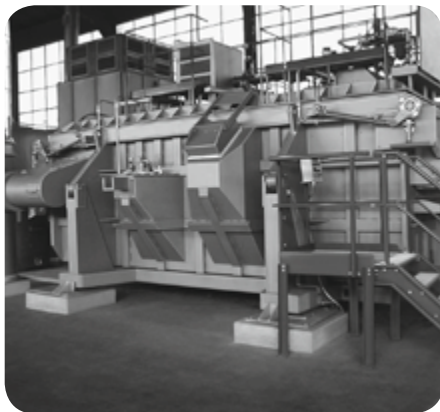

Shaft melting furnace



Incineration installation for thermal regenerative flue air purification

Examples of application

Self recuperative burner for direct heating systems

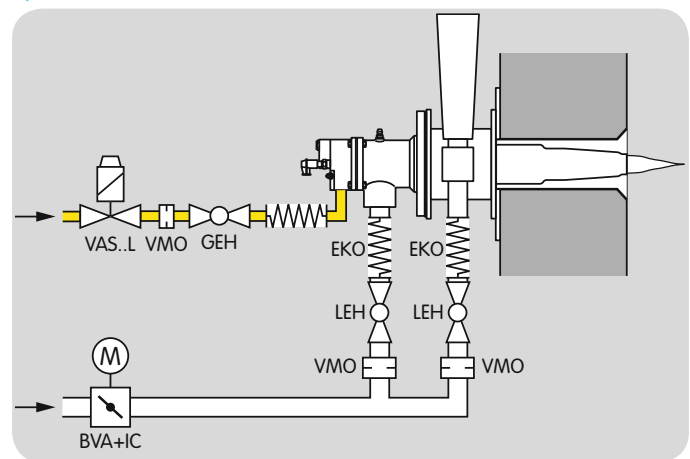

Self recuperative burner in a direct heating system with an inductor for evacuating the flue gases from the furnace. The inductor generates a vacuum with a centrally positioned nozzle and thus draws the flue gases out of the furnace chamber through the burner's heat exchanger. The measuring orifices VMO are designed to record the gas and air flow rates.

Continuous control with pneumatic ratio control system

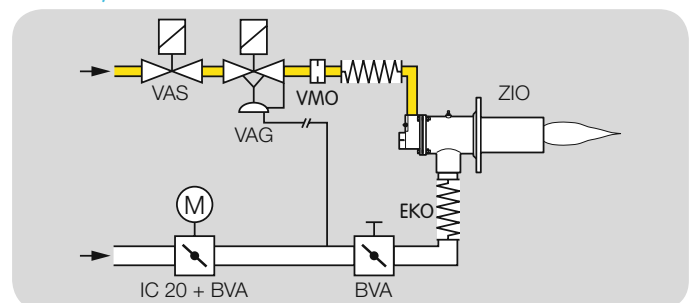

With this type of control, the mixture setting can be maintained over a wide control range while at the same time preventing air deficiency. This type of control is used in melting furnaces in the aluminium industry or in regenerative incineration installations in the environment industry, for example. Here, the measuring orifice VMO is designed to record the gas flow rate.

Flow rate

The characteristic curves are measured at the test points at 15°C (59°F) for the individual washers.

VMO 110, VMO 115, VMO 120, VMO 125

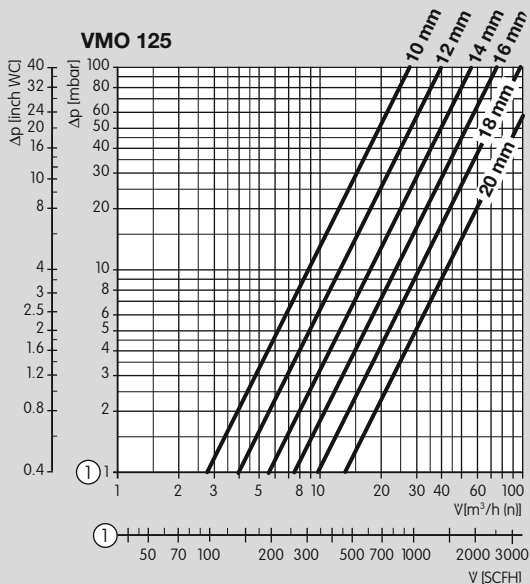
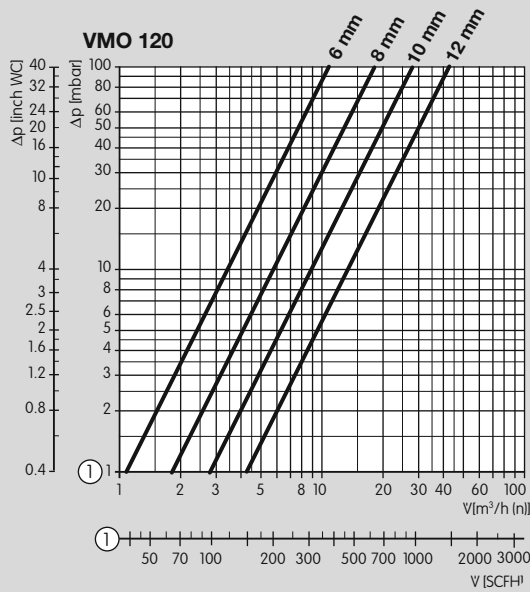
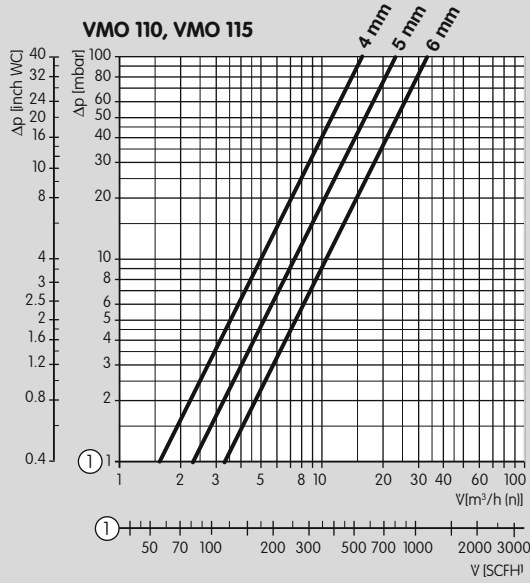

VMO 232, VMO 240, VMO 250

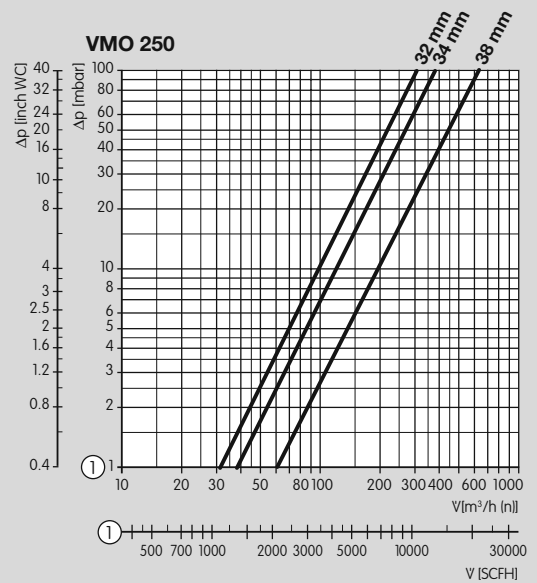
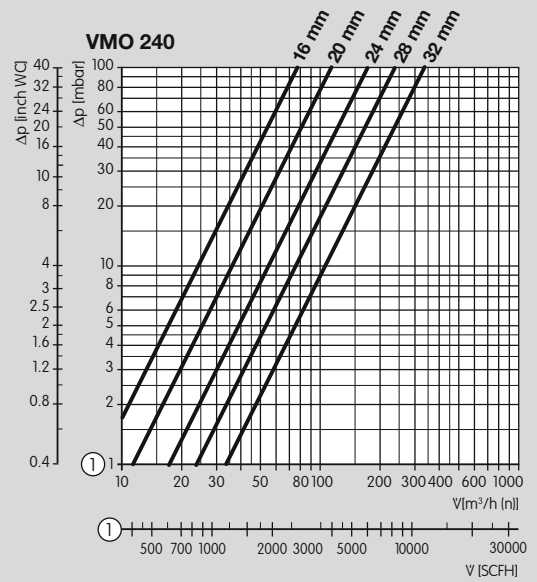
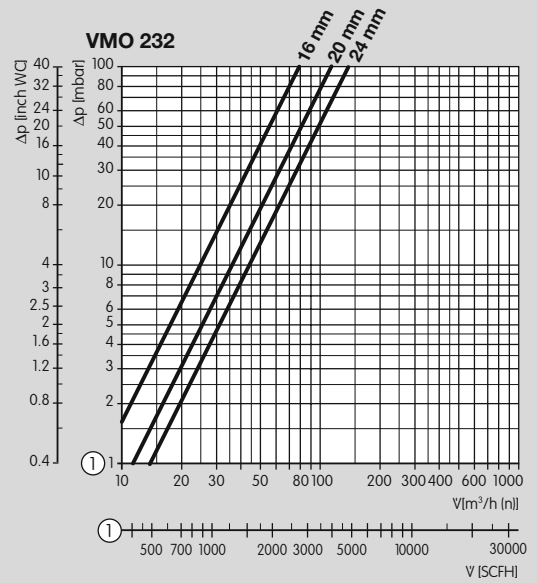

Legend

① = natural gas ($\rho = 0.80 \text{ kg/m}^3$)

Type code

Code	Description
VMO	Measuring orifice
1-2	Size
-	Without inlet and outlet flange
10-50	Nominal inlet and outlet diameter in DN
R	Rp internal thread
N	NPT internal thread
F	Flange to ISO 7005
05	$p_{e \max}$ 500 mbar
M	With pressure test points
04 - 38	Orifice diameter* in mm

* Delivery of washers with individual orifice diameter on request.

Technical data

Gas types: natural gas, LPG (gaseous), biologically produced methane (max. 0.1 %-by-vol. H₂S) or air; other gases on request.

The gas must be dry in all conditions and must not contain condensate.

Max. inlet pressure p_U : max. 500 mbar (7.25 psig).

Ambient temperature:
-20 to +60°C (-4 to +140°F),
no condensation permitted.

Storage temperature:
0 to +40°C (-4 to +104°F).

Housing: aluminium.

Connection flanges with internal thread:
Rp to ISO 7-1,
NPT to ANSI/ASME.

Maintenance

Check for external tightness at least once per annum, at least twice per annum for operation with biologically produced methane.



elster
Kromschroeder

Detailed information on this product



http://docuthek.kromschroeder.com/doclib/main.php?language=1&folderid=401084&by_class=6

Contact

www.kromschroeder.com → Sales

Elster GmbH
Postfach 2809 · 49018 Osnabrück
Strothweg 1 · 49504 Lotte (Büren)
Germany
T +49 541 1214-0
F +49 541 1214-370
info@kromschroeder.com
www.kromschroeder.com

We reserve the right to make technical modifications in the interests of progress.
Copyright © 2013 Elster GmbH
All rights reserved.